

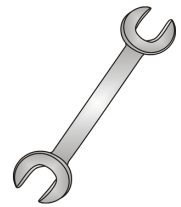

# Tow-Trust Towbars

Important: Please read General Notes overleaf before fitting



Issue 8

## TKIA3VK Hyundai Tucson (TL & NX4) / Kia Sportage (QL / QLE & NQ5)

Item	Qty	Description	Item	Qty	Description
A	1	TKIA3 Crossmember	D	1	Flip Up Socket Plate (TTFP/LH)
B	1	6214 Detachable Neck	E	4	M12 x 50 Bolts & S/P Washers
C	2	Handed Bumper Brackets	F	2	M12 x 25 Bolts & S/P Washers
X	2	Tucson NX4 2020> / Sportage NQ5 2022> Spacers	G	2	M12 x 22 Bolts & S/P Washers
			H	2	M6 X 25 Bolts & Nyloc Nuts
			K	2	Small Black Plastic Rivets (Sensor)
			L	4	12 x 40 Flat Washers
			M	4	12 x 25 Flat Washers
			N	2	6 x 20 Flat Washers
			R	1	M12 x 40 Bolt

### BUMPER REMOVAL:

1. Remove the rear light clusters to reveal two bumper fixings beneath each light, remove three fixings along the lower edge, four fixings in each wheel arch. Remove the under trays from either side of the vehicle (four fixings securing each tray). Remove the fixings through the rear panel securing the rear impact beam. Unplug the wiring loom from the bumper, starting at the bumper tips release the bumper from the vehicle bodywork.
2. Remove the rear impact beam from inside the bumper. (This is not refitted with the Towbar assembly)
3. Remove the wiring loom and sensor from the rear beam and refit to item A using item K.

### TOWBAR INSTALLATION:

1. Locate the Towbar mounting points on the outside face of each chassis member and remove any under seal or mastic.
2. Insert Item A into the open ends of the chassis and secure in place using Item E and Item L. (**Note:** Hyundai Tucson (NX4) 2020> and Kia Sportage (NQ5) 2022> will require Items X as spacers) (**Note:** Kia Sportage (QL/QLE) will require Item R at the rearmost O/S mount).
3. Using Item H with Item N loosely fix Items C to Item A. (leave loose until fitment of the rear bumper then fully tighten)
4. Using Item F with Item M and Item G with Item M fix Item B and Item D to Item A.
5. Fully tighten all fixings ensuring the Towbar is rigid, square and secure.
6. Kia Only: QL / QLE Cut off the central bumper tag from the bumpers lower edge, NQ5 Cut bumper as per sketch below.
7. Refit the rear bumper (using the original bumper fixings to secure the lower edge to Item C) and refit rear light clusters.

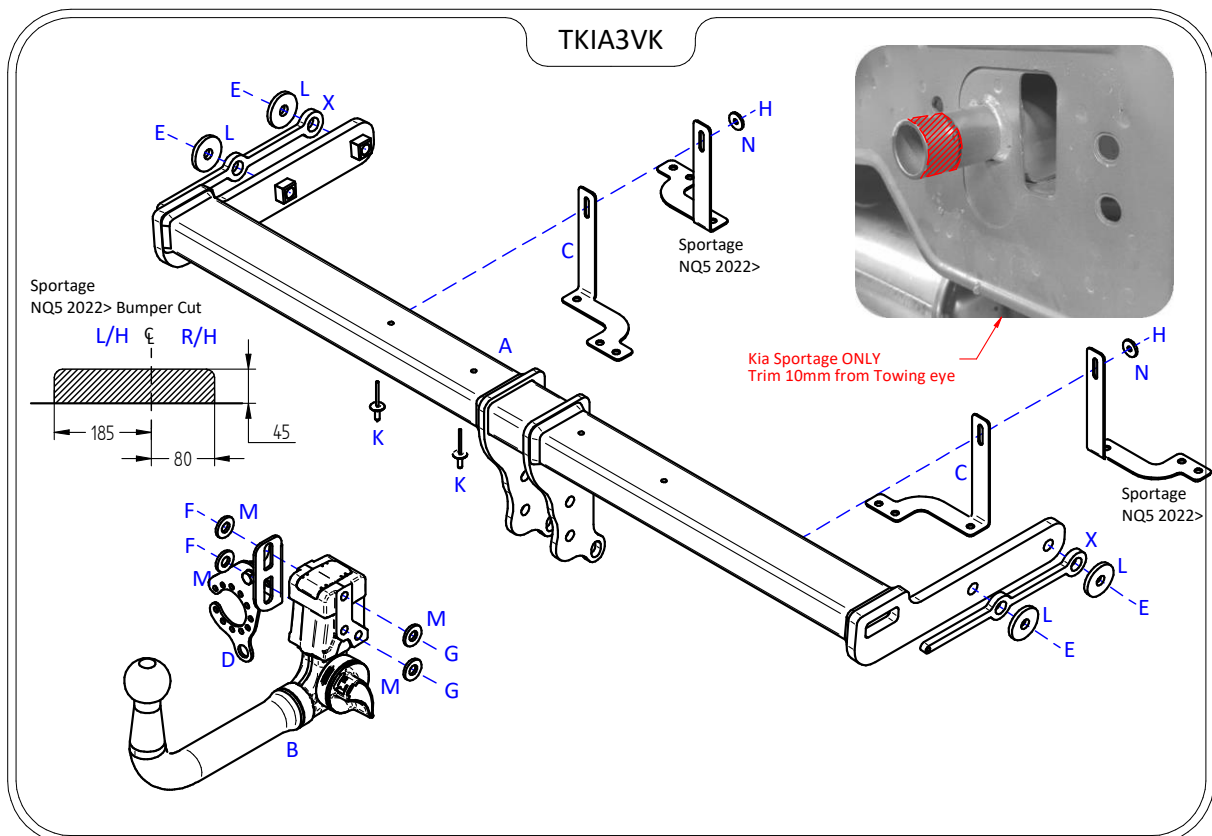

### Note:

1. Torque Settings see notes overleaf.
2. Nose load limits and vehicle manufacturers trailer / caravan weight limits must be observed.