

**IN8057 Pipe Carrier**

**FX4011 X4**  
(M8)

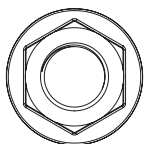

**FX4048 X4**  
(M8X50)

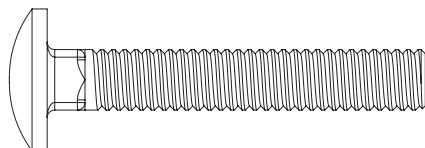

**ME0446 X4**

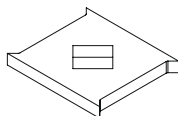

**ME0897 X2**

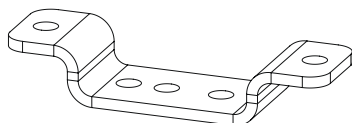

**TOOLS REQUIRED**

13MM X 1

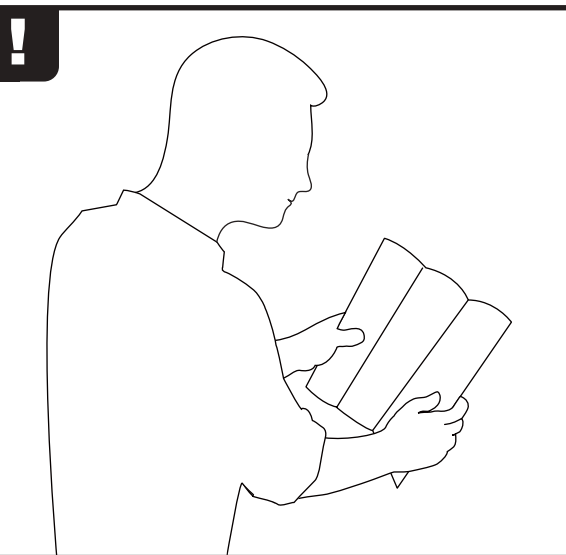
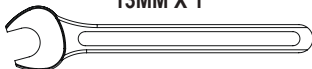

1. Regularly inspect all fixings and parts. Any damaged or worn parts should be immediately removed from the vehicle and replaced.

2. Van Guard Accessories LTD and/ or its distributors do not accept liability for:

- Any products that have been fitted incorrectly.
- Any products which have been fitted to the incorrect vehicle.
- Any products that have been modified in any way or are being used for any purpose that they are unintended for.

3. It is important that the end user receives this document and that instructions are retained for future use.



1. Inspecter régulièrement toutes les fixations et les pièces. Les pièces endommagées ou usées doivent être immédiatement retiré du véhicule et remplacé.

2. Van Guard Accessoires Ltd et/ ou ses distributeurs n'accepte pas de responsabilité pour:

- Les produits qui ont été ajustés de manière incorrecte.
- Les produits qui ont été montés sur le véhicule incorrect.
- Les produits qui ont été modifiés de quelque façon ou sont utilisés à toutes fins qu'ils sont involontaires.

3. Il est important que l'utilisateur final reçoit ce document et que les instructions soient conservés pour une utilisation futur.



1. Prüfen Sie regelmäßig alle Befestigungen und Teile. Alle verschlissenen oder beschädigten Teile sollten sofort aus dem Fahrzeug ausgebaut und erneuert.

2. Van Guard Accessories LTD und/ oder seinen Händlern keine Haftung für:

- Sämtliche Produkte, die falsch montiert worden.
- Alle Produkte, die auf die falsche Fahrzeug.
- Alle Produkte, die nicht in irgendeiner Weise verändert oder verwendet für jeden Zweck, sie sind unbeabsichtigt.

3. Es ist wichtig, dass der Endbenutzer erhält dieses Dokument und die Anweisungen für eine zukünftige Verwendung aufbewahrt werden.



1. Undersøg med jævne mellemrum alle løsdele og fæstninger. Beskadigede eller slidte dele bør straks fjernes fra køretøjet og repareres eller erstattet.

2. VanGuard Accessories Ltd og/eller deres distributører accepterer ikke ansvar for:

- Produkter der ikke er monteret korrekt som angivet i monteringsvejledning.
- Produkter der er blevet monteret på et køretøj, de ikke er beregnede til.
- Produkter der er blevet modificerede på nogen måde eller bliver brugt på en måde, hvortil de ikke er beregnede.

3. Det er vigtigt, at dette dokument overdrages til slutbruger af produktet og at vejledning er gemt til senere brug.

## VG200

## Pipe Carrier - Maxi

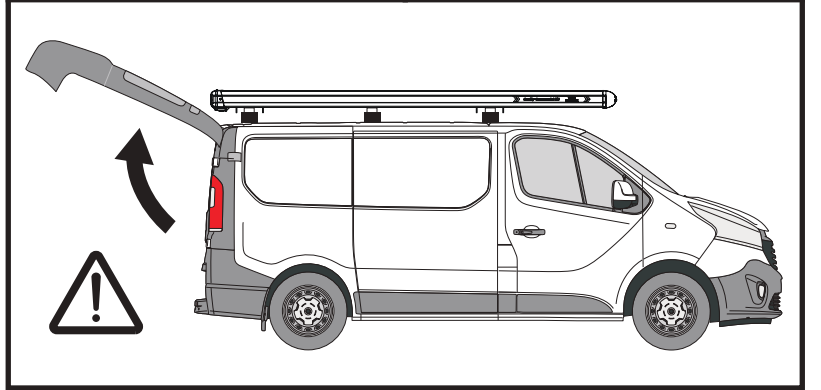
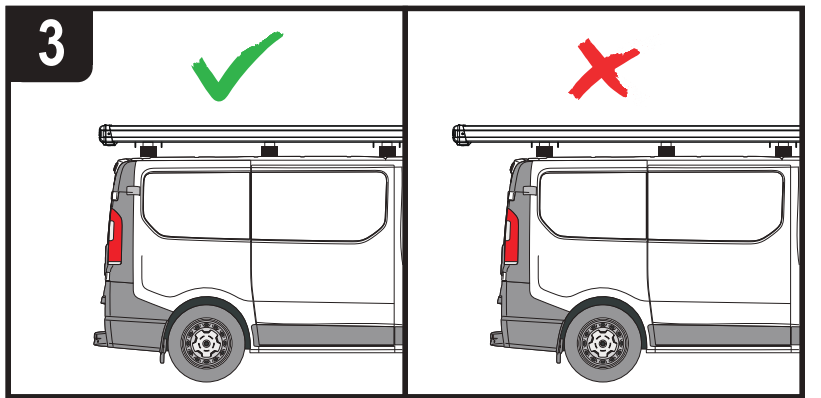
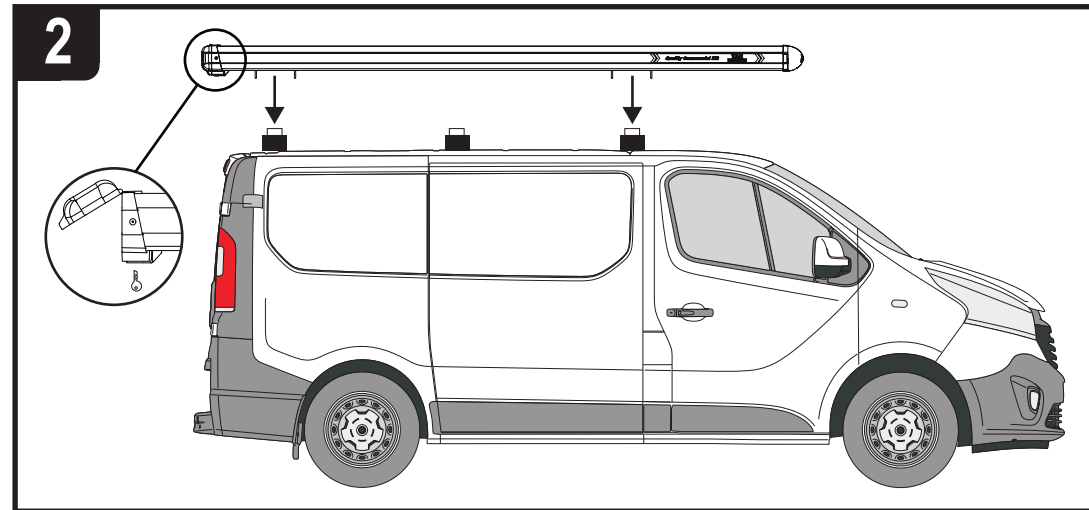
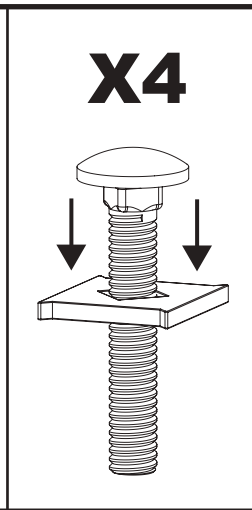
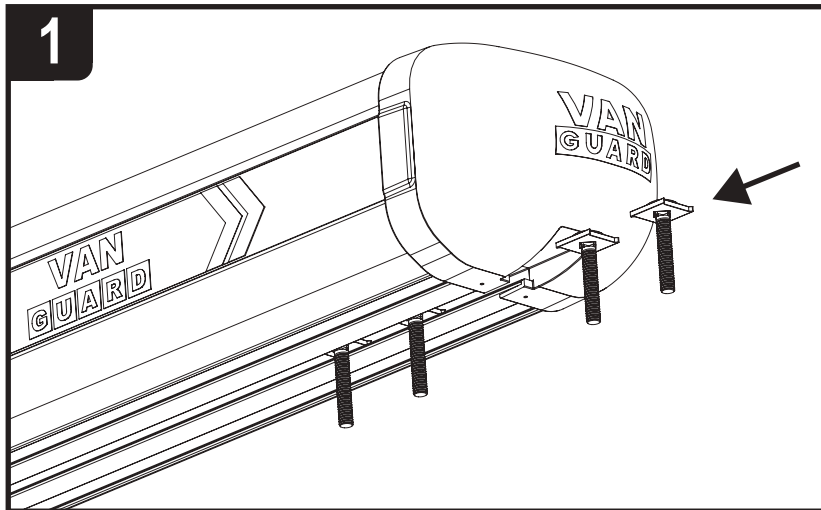

**4**

**12Nm**

**4.1**

ROOF BAR SIZE	
20mm	20 - 30mm

**4.2**

ROOF BAR SIZE	
20mm - 30mm	20 - 30mm

**4.3**

ROOF BAR SIZE	
30mm - 40mm	20 - 30mm

**4.4**

ROOF BAR SIZE	
30mm - 60mm	20 - 50mm

## VG400 *Pipe Carrier - Standard*

